

SS16-F05/F07
TECHNICAL DATA

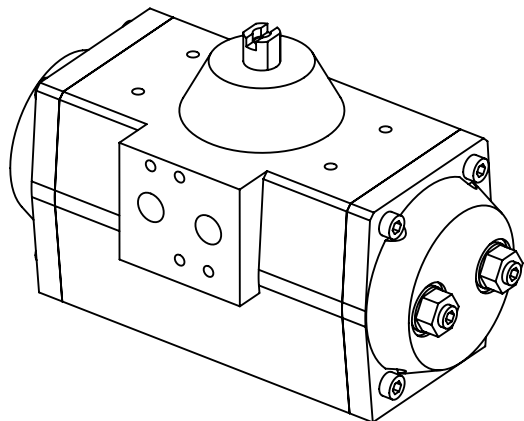

DIMENSIONS TO
ISO 5211 - DIN 3337
AND NAMUR VDI/VDE 3845

DIMENSIONS IN INCHES

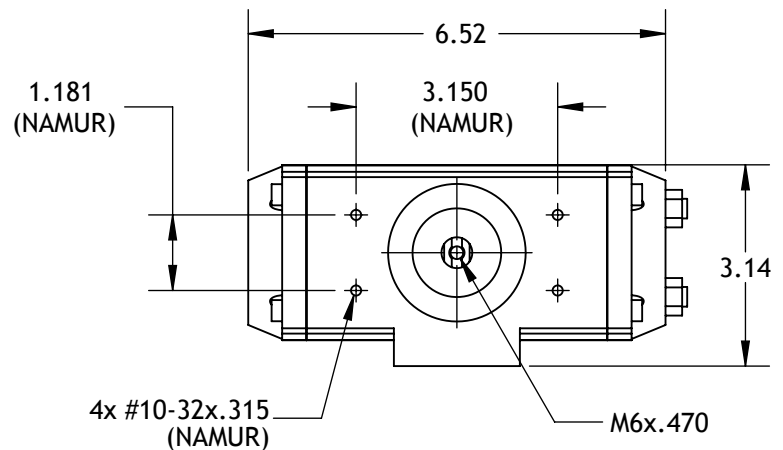
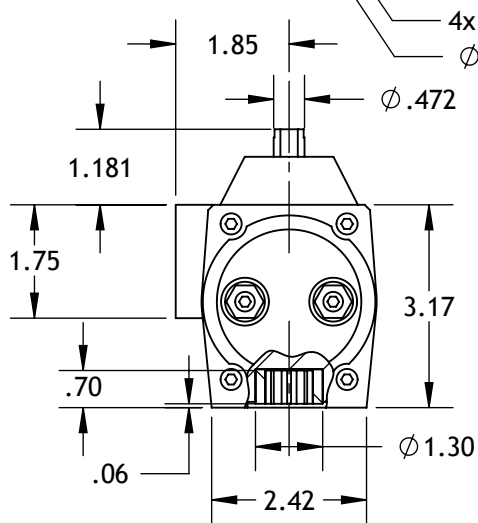
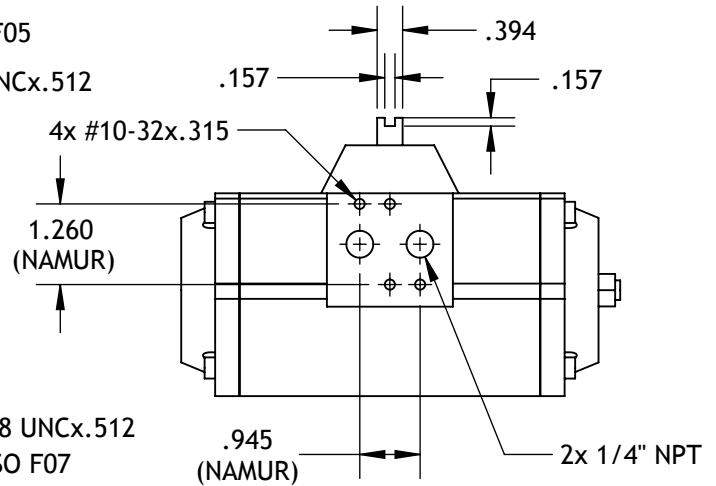
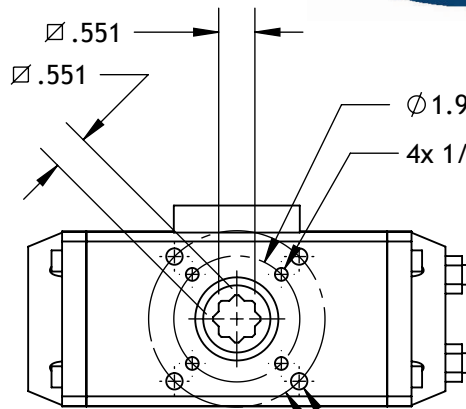

	Double Acting	Spring Return
Air Consumption (Full Cycle)	25.6 in ³	11.2 in ³
Weight	8.1 lbs	8.5 lbs (7+5 Springs)

Max-Air Technology Inc.

751 Hoff Road - O'Fallon, Missouri 63366 U.S.A.
www.max-airtechnology.com info@max-airtechnology.com