



MAX-LINK MAB SERIES

Stainless Steel Cast Brackets

Technical Data

MAX-LINK MAB Series valve brackets conform to ISO 5211 standards and are available in four sizes ranging from F03 up to F12. Limit switch brackets are designed to 80x30 NAMUR standards and are available in 20mm and 30mm heights. Brackets are constructed from investment cast CF8 (304) stainless steel for strength and compatibility in corrosive environments.

Features and Benefits

- ISO 5211 standard valve mounting
- NAMUR limit switch mounting, compatible with most limit switch brands
- CF8 (304) stainless steel, heavy-duty investment cast design
- Precision ground faces for accurate mounting
- Tag loop feature on all brackets for easy identification
- Valve brackets designed with integrated lockout holes
- Easy bolt switch mounting with limit switch brackets

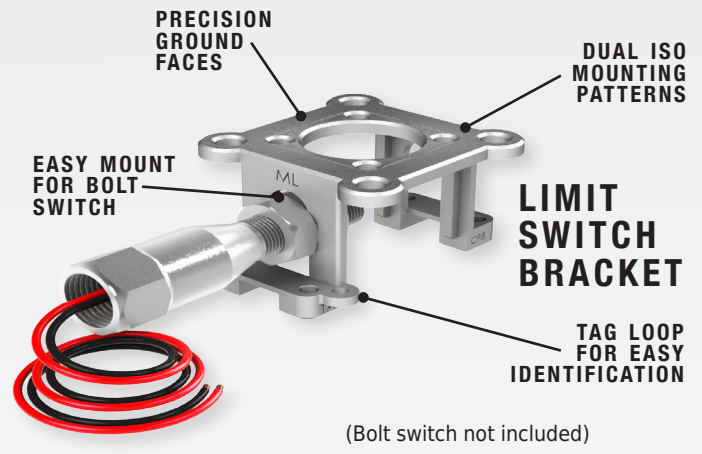
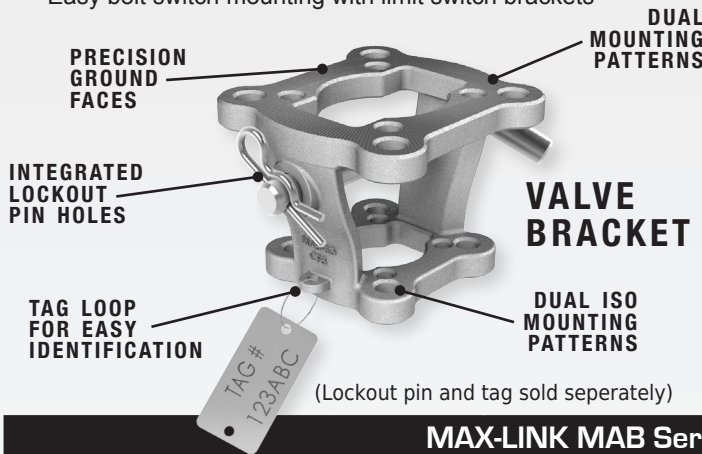

MAX-LINK MAB Series Mounting Brackets

	Part Number	Box Qty	Item Description
	MAB-S1	125	Investment Cast SS Bracket, F03/F04 to F04/F05 ISO Mounting, 40mm [1.57"] Height, w/ Lockout Hole & Tag Loop
	MAB-S2	48	Investment Cast SS Bracket, F04/F05 to F05/F07 ISO Mounting, 50mm [1.97"] Height, w/ Lockout Hole & Tag Loop
	MAB-S3	18	Investment Cast SS Bracket, F05/F07 to F07/F10 ISO Mounting, 75mm [2.95"] Height, w/ Lockout Hole & Tag Loop
	MAB-S4	8	Investment Cast SS Bracket, F10 to F10/F12 ISO Mounting, 80mm [3.15"] Height, w/ Lockout Hole & Tag Loop
	MAB-SL1	45	Investment Cast SS Limit Switch Bracket, Namur Pattern 30x80x20mm, ISO F05/2.25"SQ Mounting, w/ Bolt Switch Hole & Tag Loop, <u>with</u> hardware
	MAB-SL2	36	Investment Cast SS Limit Switch Bracket, Namur Pattern 30x80x30mm, ISO F05/2.25"SQ Mounting, w/ Bolt Switch Hole & Tag Loop, <u>with</u> hardware

The Best Way to Automate Your Process

Valve Bracket Dimensions

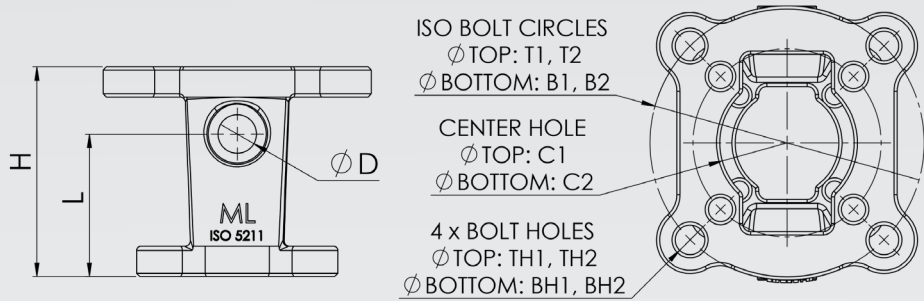

Size	H	L	D	Top ISO	T1	TH1	T2	TH2	Bottom ISO	B1	BH1	B2	BH2	C1	C2	Pin
MAB-S1	1.57	1.11	0.37	F04/F05	1.65	0.24	1.97	0.30	F03/F04	1.42	0.24	1.65	0.24	1.02	1.02	5/16" x 2"
MAB-S2	1.97	1.43	0.43	F05/F07	1.97	0.30	2.97	0.40	F04/F05	1.65	0.26	1.97	0.30	1.45	1.20	3/8" x 3"
MAB-S3	2.95	1.99	0.55	F07/F10	2.76	0.35	4.02	0.43	F05/F07	1.97	0.28	2.76	0.35	1.97	1.52	1/2" x 4"
MAB-S4	3.15	2.30	0.68	F10/F12	4.02	0.44	4.92	0.51	F10	4.02	0.44	-	-	3.00	2.75	5/8" x 5"

Limit Switch Bracket Dimensions

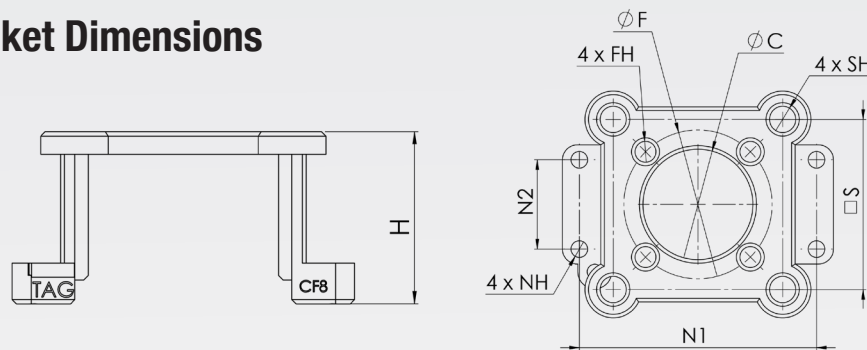

Size	NAMUR	H	N1	N2	NH	S	SH	F	FH	C
MAB-SL1	30x80x20	1.77	3.15	1.18	0.22	2.25	0.35	1.97	0.28	1.46
MAB-SL2	30x80x30	2.17	3.15	1.18	0.22	2.25	0.35	1.97	0.28	1.46

Box Quantity Pricing Available!

(Call for pricing and availability.)

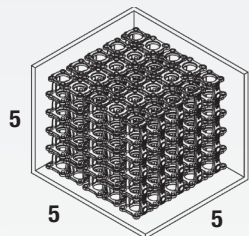

5x5x5=125
49.6lbs

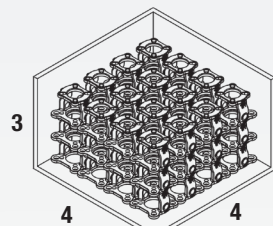

4x4x3=48
29.6lbs

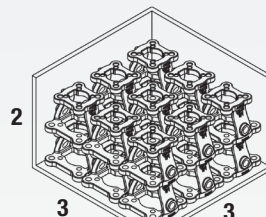

3x3x2=18
36.9lbs

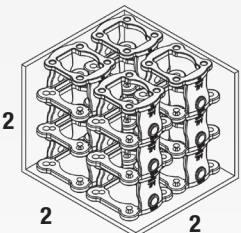

2x2x2=8
41lbs

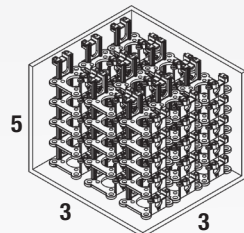

3x3x5=45
26.8lbs

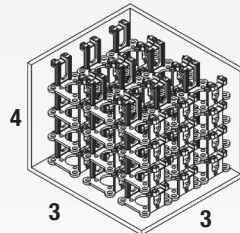

3x3x4=36
21.4lbs

Heavy Duty SS Brackets Available for Max-Air Limit Switches

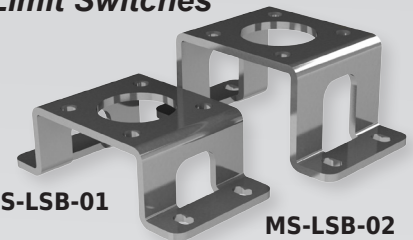

MS-LSB-01

MS-LSB-02

Heavier gauge 300 series SS brackets available for demanding, high vibration applications. Standard Namur 20mm/30mm heights, and custom options also available.



NORTH AMERICA
Max-Air Technology, Inc.
751 Hoff Rd
O'Fallon, Missouri 63366
United States of America
Tel: +1.636.272.4934
Toll Free: 888.842.9998
Fax: 636.272.4937

EUROPE
Emme Technology, Srl.
Via Di Vittorio, 307/27
20099 Sesto San Giovanni
Milan, Italy
Tel: +39.02.2626.2174
Fax: +39.02.2622.0777