

SS21
TECHNICAL DATA

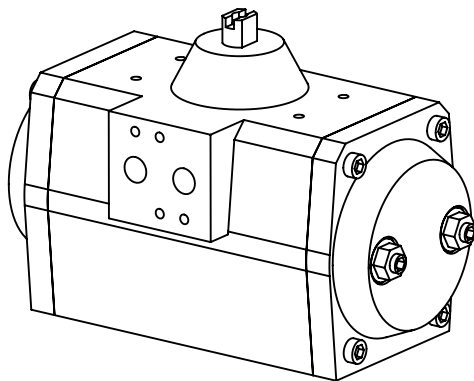

DIMENSIONS TO
ISO 5211 - DIN 3337
AND NAMUR VDI/VDE 3845

DIMENSIONS IN INCHES

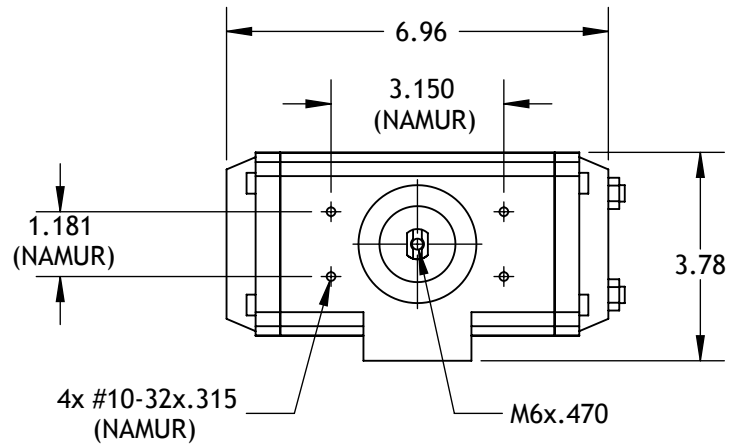
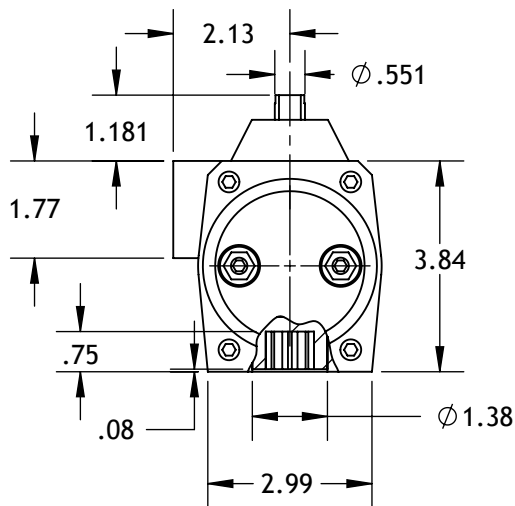
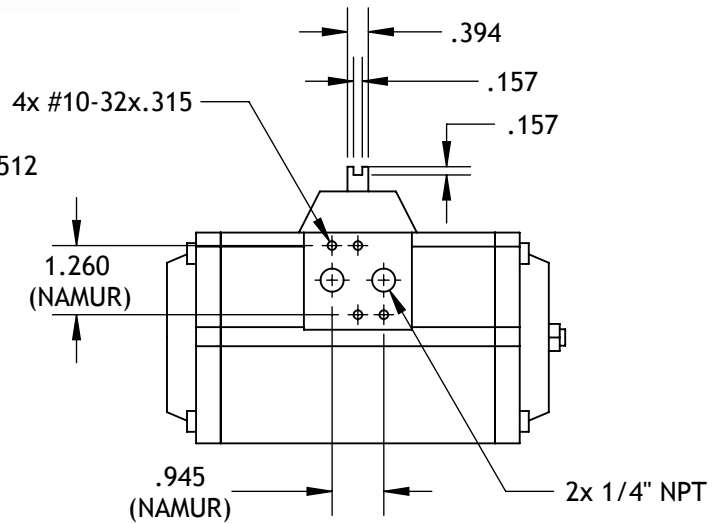
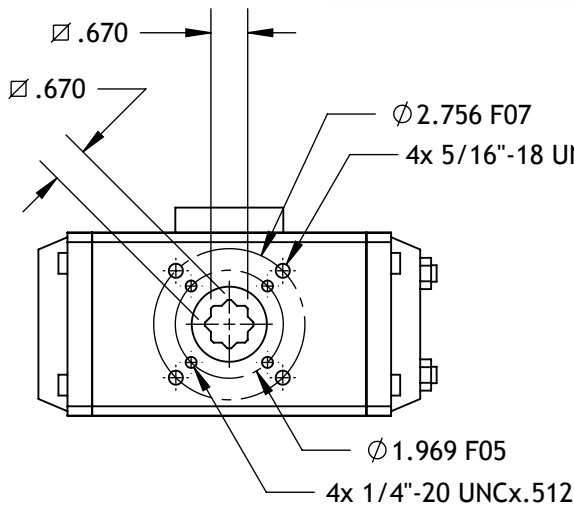

	Double Acting	Spring Return
Air Consumption (Full Cycle)	44.4 in ³	18.1 in ³
Weight	11.0 lbs	11.8 lbs (7+5 Springs)

Max-Air Technology Inc.

751 Hoff Road - O'Fallon, Missouri 63366 U.S.A.
www.max-airtechnology.com info@max-airtechnology.com