

SS31
TECHNICAL DATA

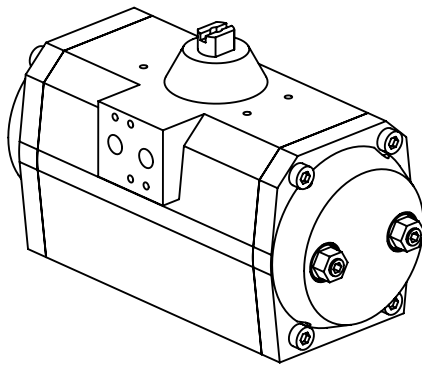

DIMENSIONS TO
ISO 5211 - DIN 3337
AND NAMUR VDI/VDE 3845

DIMENSIONS IN INCHES

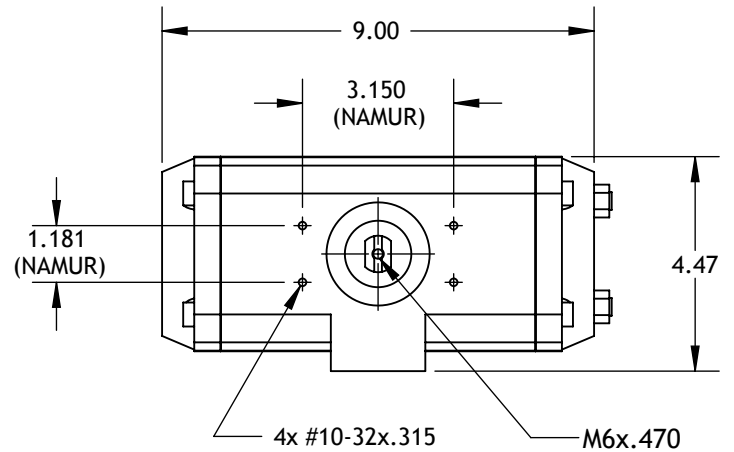
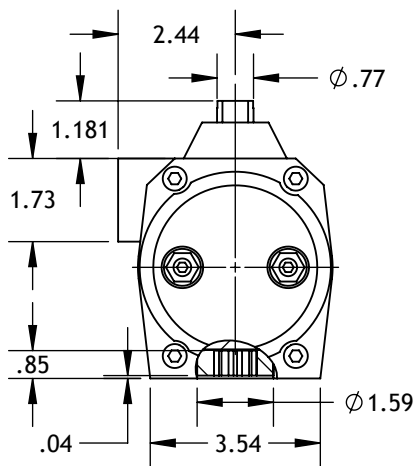
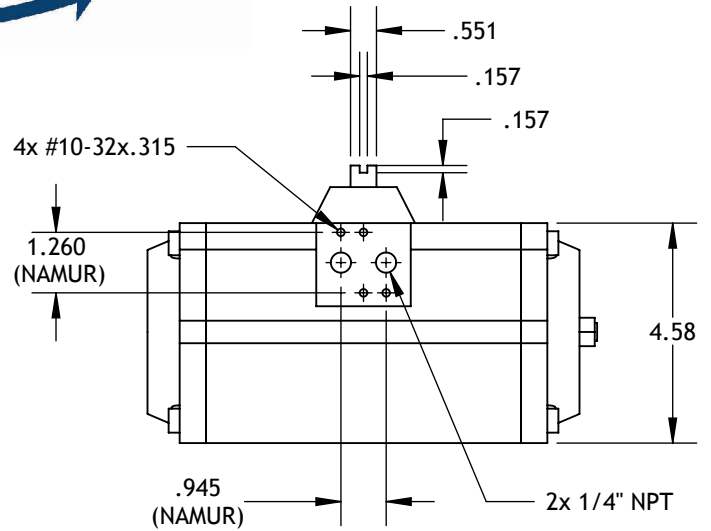
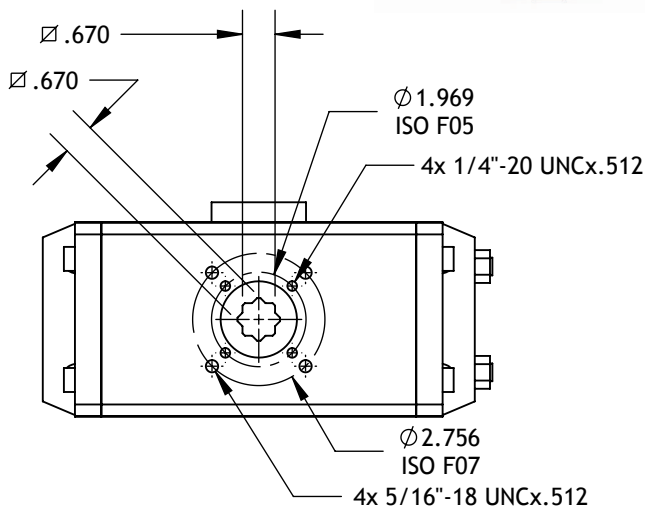

	Double Acting	Spring Return
Air Consumption (Full Cycle)	88.9 in ³	40.6 in ³
Weight	19.3 lbs	20.9 lbs (7+5 Springs)

Max-Air Technology Inc.

751 Hoff Road - O'Fallon, Missouri 63366 U.S.A.
www.max-airtechnology.com info@max-airtechnology.com